

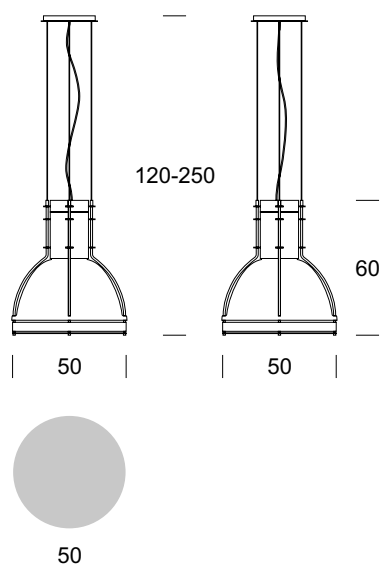

PENDANT LAMP BETA D

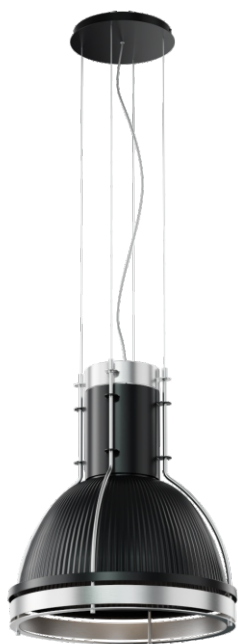





PRODUCT DESCRIPTION

BETA luminaires are designed to illuminate high spaces such as shopping centers, malls, car showrooms, halls, etc. They combine decorative elegance with technical parameters of industrial lighting luminaires. Mounting structure is made of chrome steel, covers can be painted in any RAL color. Standard luminaires available in graphite or silver. Reflector of anodized aluminum. The electrical system is ready for discharge, sodium metal-halogen lamps.

TECHNICAL DATA

Number of light sources	1
Voltage	230 V
Source of light	Recommended: 1x E27 or 50 W LED
Optics	S
Light color	-
Protection class	I
Degree of protection	IP20
CE ∇ \oplus	Yes
Mounting	On the ceiling

MATERIAL - FINISH - VARIANTS

Body material	Metal
Metal colour	 Inox  Chrome  Black
Lampshade material	Glass
	 Colourless  RAL
Switching on	Switch in the wall

LOGISTICS

Packaging	a collective carton according to order individual carton
-----------	---

